

SYSTEM Termoplus 78

Cross-sectional overview

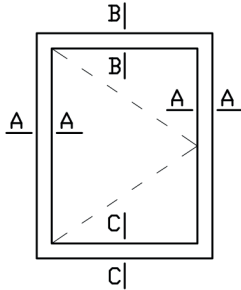

Single-leaf single-hung window

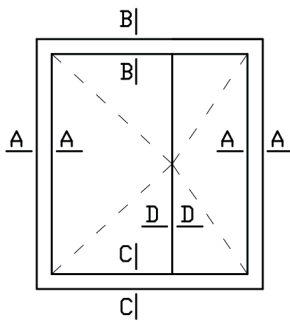

Folding single-hung window, movable post

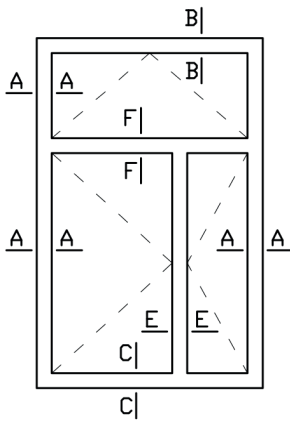

Folding double-hung window, fixed post

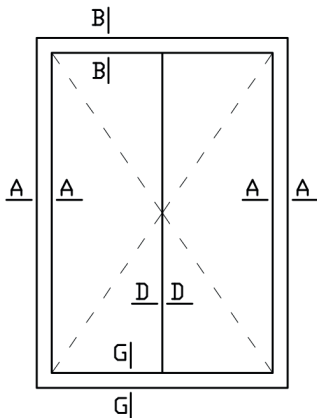

Double-hung balcony doors

HORIZONTAL SECTION - WINDOW,
BALCONY
A₁-A₁

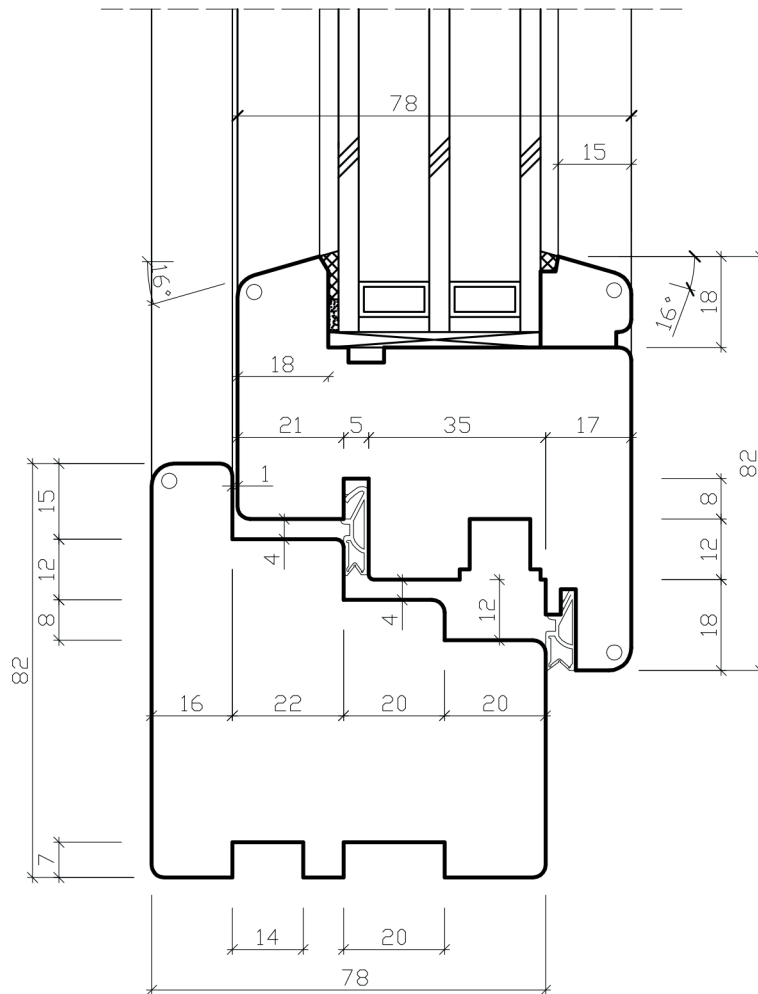

The outer edges: $\bigcirc R=4,5\text{mm}$

Termoplus 78 | Section A₁-A₁ | Scale: 1:1.5

HORIZONTAL SECTION - FIXED GLAZING
A₂-A₂

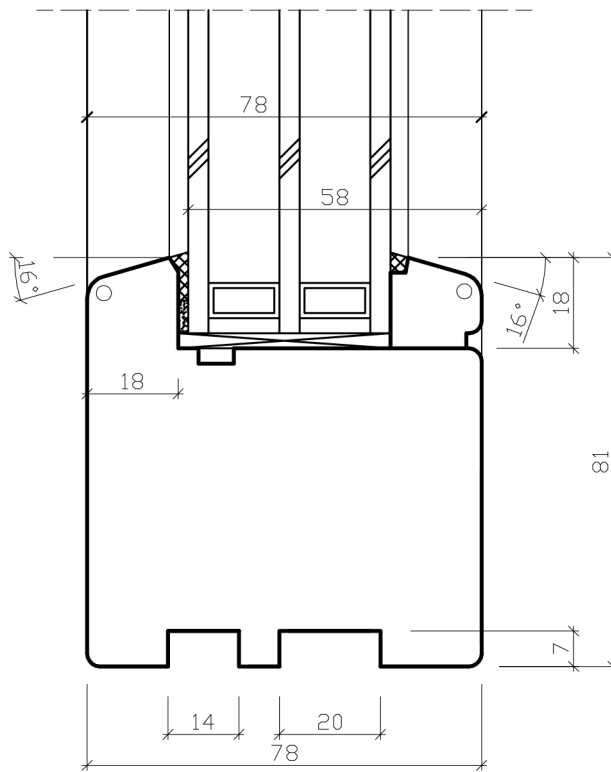

The outer edges: ○ R=4,5mm

Termoplus 78 | Section A₂-A₂ | Scale: 1:1.5

VERTICAL SECTION OF WINDOWS

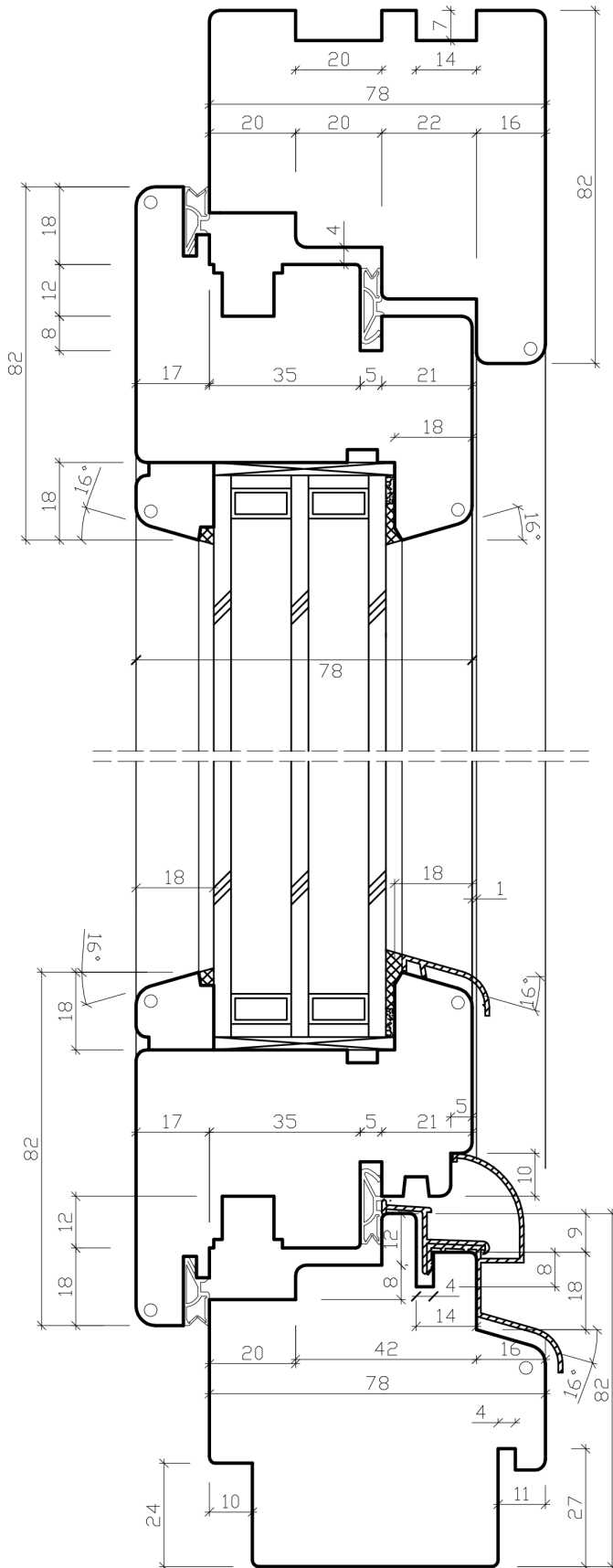

B-B

C-C

The outer edges: $\bigcirc R=4,5\text{mm}$

Termoplus 78 | Section B-B i C-C | Scale: 1:1.5

HORIZONTAL SECTION - MOVABLE POST
D-D

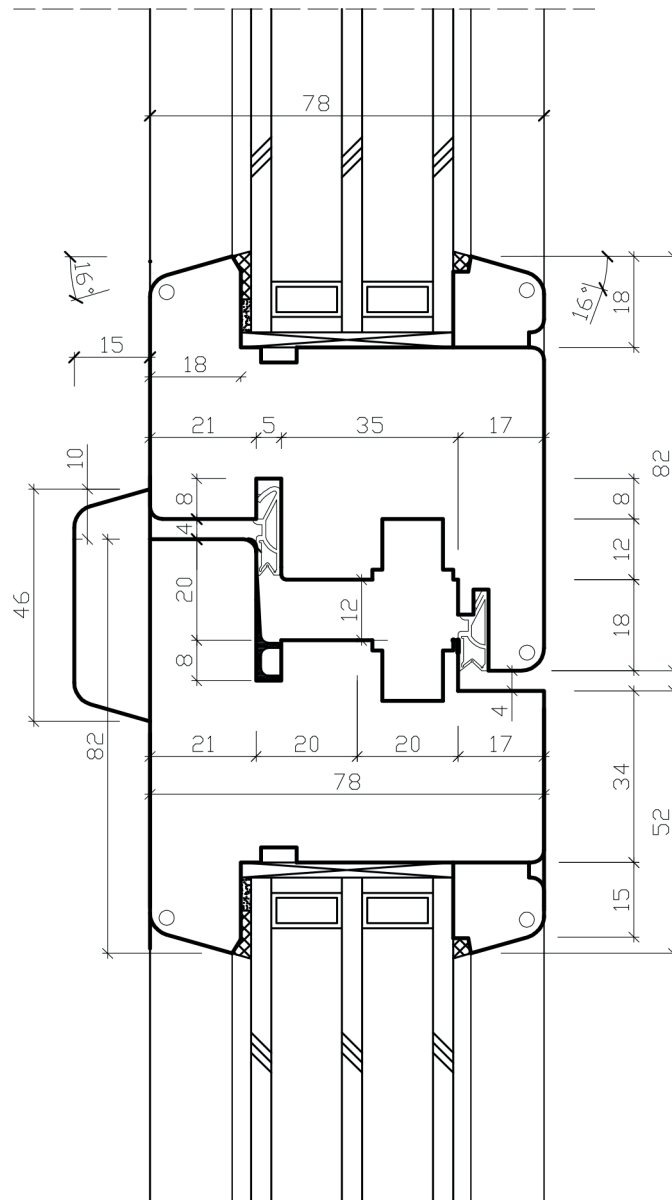

Termoplus 78 | Section D-D | Scale: 1:1.5

HORIZONTAL SECTION - FIXED POST
E-E

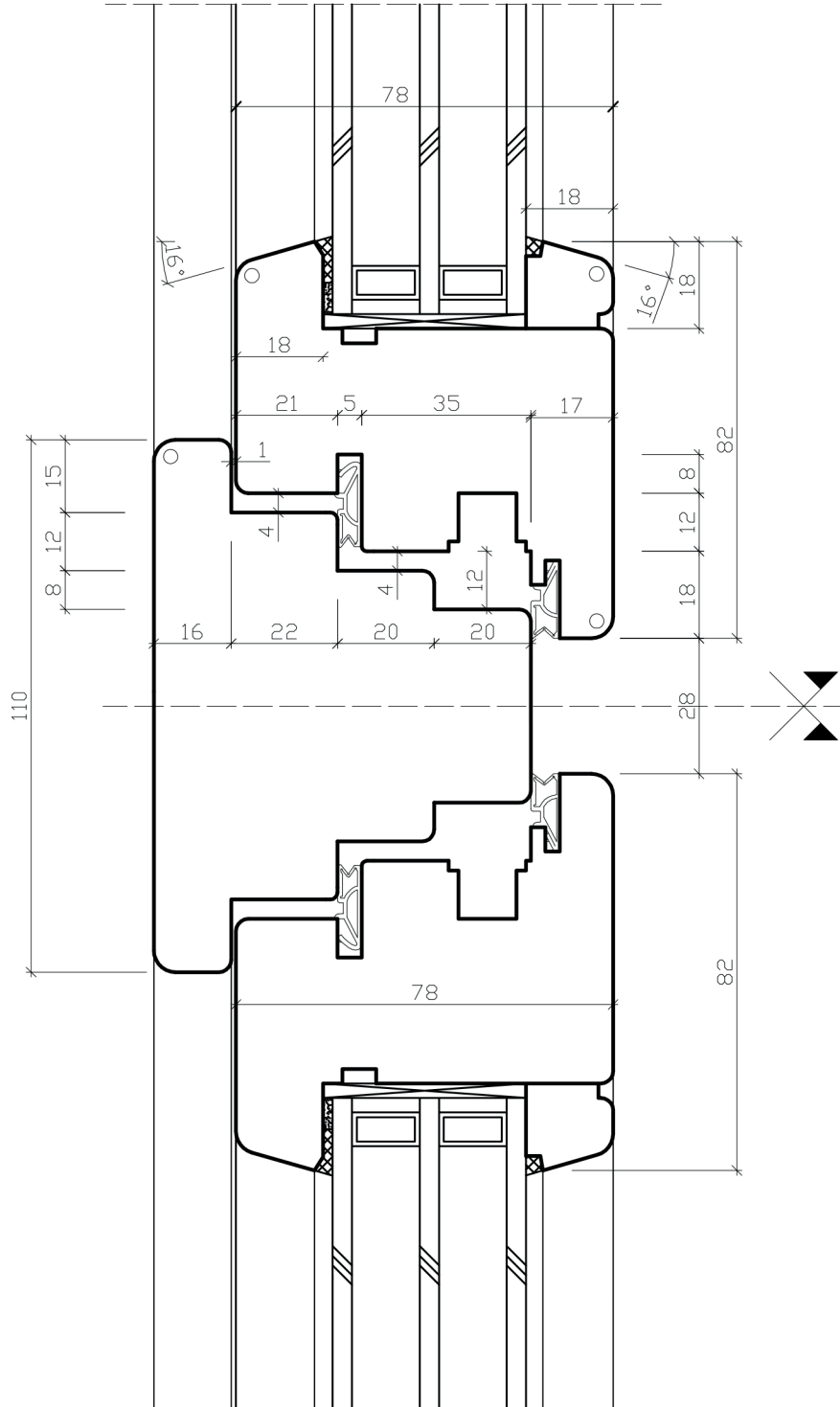

The outer edges: $\bigcirc R=4,5\text{mm}$

Termoplus 78 | Section E-E | Scale: 1:1.5

VERTICAL SECTION - TRANSOM BAR

F-F

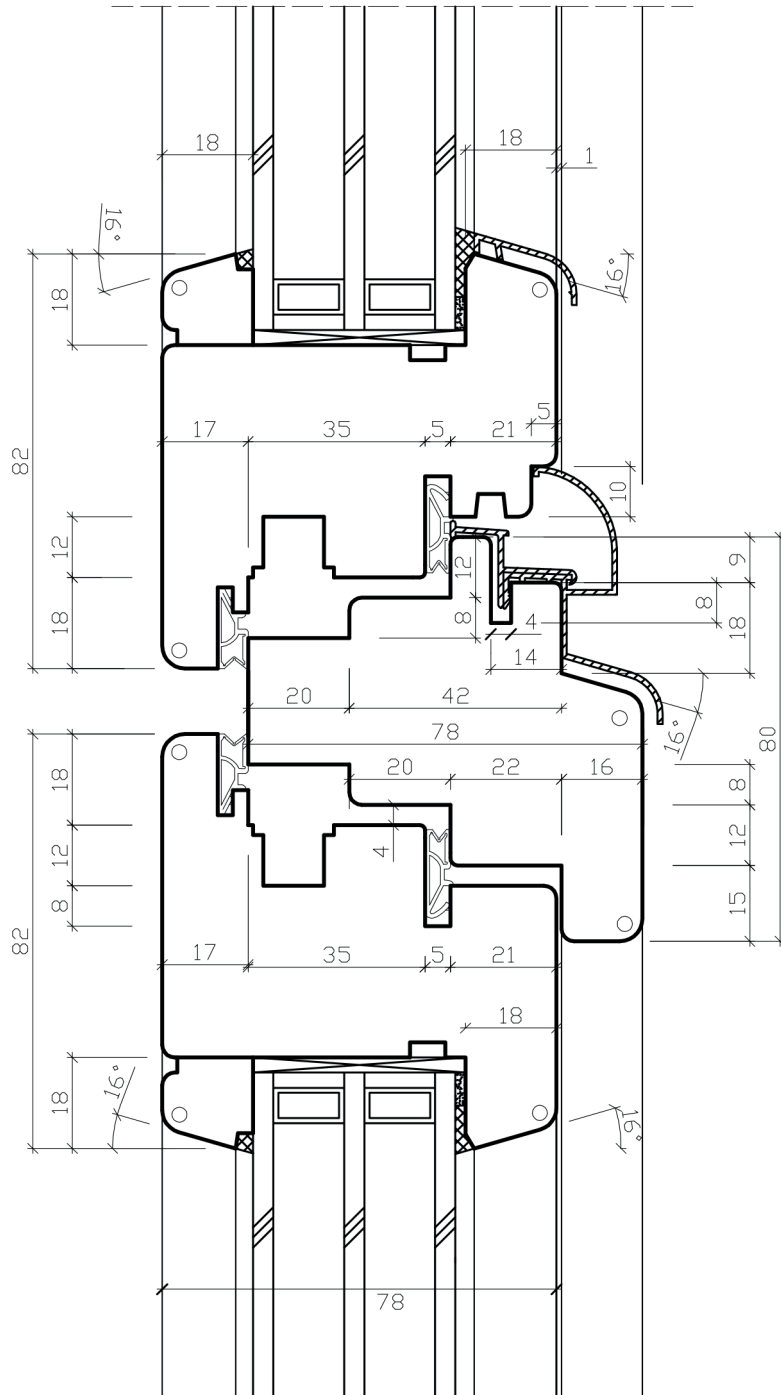

The outer edges: $\bigcirc R=4,5\text{mm}$

Termoplus 78 | Section F-F | Scale: 1:1.5

VERTICAL SECTION - BALCONY
 G-G

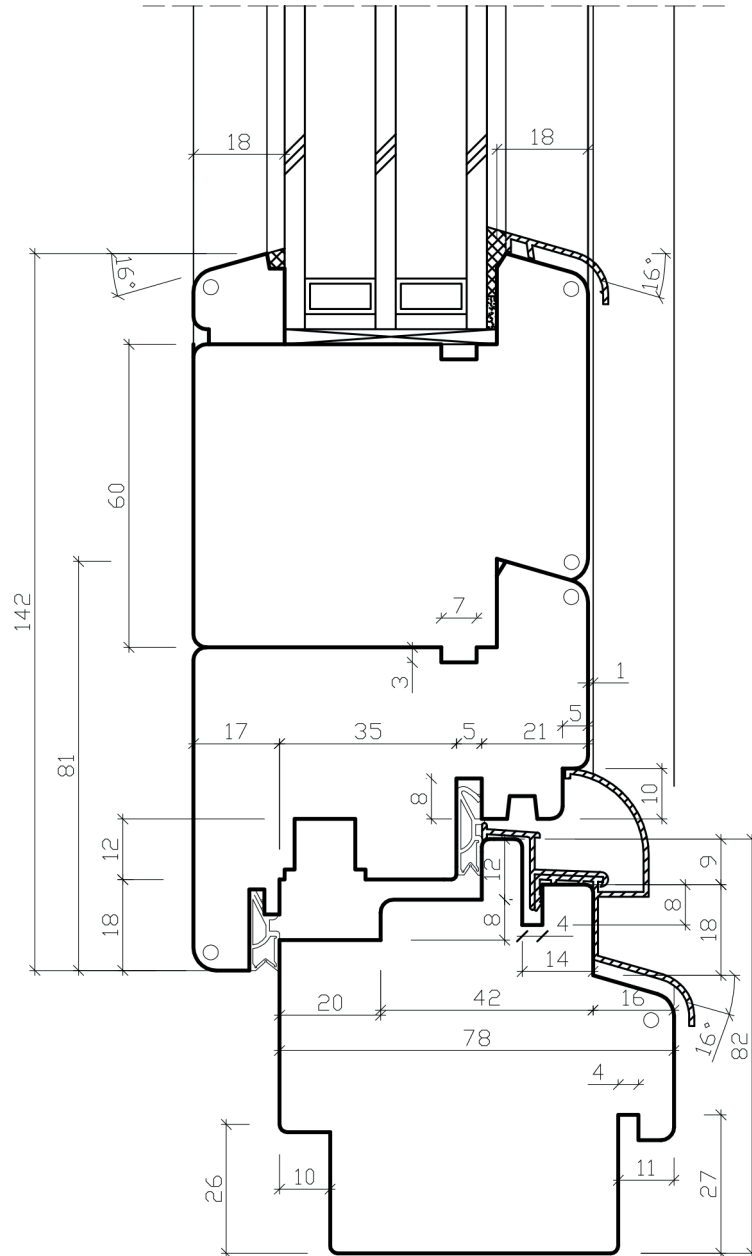

The outer edges: $\bigcirc R=4,5\text{mm}$

Termoplus 78 | Section G-G | Scale: 1:1.5